



**GLP**

**Great Lakes Parts, Inc.**

**GLP0412**



**Bill Melchior - President**

## **Wheel Nut Experts!**

Since 1981, **Great Lakes Parts** has been the leading supplier of wheel nuts to thousands of companies – all over the world!

We can assist you with design and engineering requirements. We can suggest cost-saving alternatives. We can even custom package for you – using your name and part numbers on the package labels.

## **New Products!**

Please check out some of our **new products** including:

**Skirt Nuts**...(page 11)

**Flange Nuts** for Aluminum Wheels...(page 10)

**Truck Wheel Guards**...(page 15)

**Bus Wheel Nuts**...(page 10)

**Sleeve Nuts**...(page 11)

## **Special Manufacturing!**

Additionally, we are able to manufacture and supply almost any configuration of wheel nut, bolt or stud. If you don't see it in our catalog – just ask!

## Wheel Nuts

7/16" - 20



**GL-0014**  
**Hex:** 3/4"  
**Height:** 9/16"  
**Degree:** 60  
**Plating:** Zinc



**GL-0502**  
**Hex:** 3/4"  
**Height:** 1.4"  
**Degree:** 60  
**Plating:** Chrome  
**Bulge**



**GL-0505**  
**Hex:** 13/16"  
**Height:** 1.4"  
**Degree:** 60  
**Plating:** Chrome  
**Bulge**



**GL-0097**  
**Hex:** 13/16"  
**Height:** 1.4"  
**Degree:** 60  
**Plating:** Chrome  
**Acorn**

1/2" - 20



**GL-0016**  
**Hex:** 13/16"  
**Height:** 5/8"  
**Degree:** 60  
**Plating:** Zinc



**GL-0017**  
**Hex:** 13/16"  
**Height:** 5/8"  
**Degree:** 90  
**Plating:** Zinc



LH Thread

**GL-0026**  
**Hex:** 3/4"  
**Height:** 9/16"  
**Degree:** 60  
**Plating:** Zinc



**GL-0027**  
**Hex:** 3/4"  
**Height:** 9/16"  
**Degree:** 60  
**Plating:** Zinc



LH Thread

**GL-0031**  
**Hex:** 13/16"  
**Height:** 5/8"  
**Degree:** 60  
**Plating:** Zinc



**GL-0093**  
**Hex:** 13/16"  
**Height:** 59/64"  
**Degree:** 60  
**Plating:** Zinc



**GL-0132**  
**Hex:** 13/16"  
**Height:** 1.2"  
**Plating:** Zinc  
**FORD**



**GL-0420**  
**Hex:** 7/8"  
**Height:** 1-1/8"  
**Degree:** 60  
**Plating:** Zinc

## Wheel Nuts

1/2" - 20



**GL-0098**  
**Hex:** 13/16"  
**Height:** 1.4"  
**Degree:** 60  
**Plating:** Chrome



**GL-0504**  
**Hex:** 3/4"  
**Height:** 1.4"  
**Degree:** 60  
**Plating:** Chrome  
**Bulge**



**GL-0510**  
**Hex:** 13/16"  
**Height:** 1.4"  
**Degree:** 60  
**Plating:** Chrome  
**Bulge**

9/16" - 18



**GL-0052**  
**Hex:** 7/8"  
**Height:** 3/4"  
**Degree:** 60  
**Plating:** Zinc



**GL-0053**  
**Hex:** 1"  
**Height:** 11/16"  
**Degree:** 90  
**Plating:** Zinc



**GL-0058**  
**Hex:** 1-1/16"  
**Height:** 21/32"  
**Degree:** 90  
**Plating:** Zinc



LH Thread  
**GL-0059**  
**Hex:** 1-1/16"  
**Height:** 21/32"  
**Degree:** 90  
**Plating:** Zinc



**GL-0161**  
**Hex:** 7/8"  
**Height:** 1-1/8"  
**Degree:** 60  
**Plating:** Zinc



**GL-0423**  
**Hex:** 7/8"  
**Height:** 1.5"  
**Degree:** 60  
**Stainless Cap**  
**CHRYSLER**

5/8" - 18



**GL-0044**  
**Hex:** 1-1/16"  
**Height:** 21/32"  
**Degree:** 90  
**Plating:** Zinc



**GL-0051**  
**Hex:** 1-1/16"  
**Height:** 29/32"  
**Degree:** 90  
**Plating:** Zinc



**GL-0055**  
**Hex:** 1"  
**Height:** 21/32"  
**Degree:** 90  
**Plating:** Zinc

## Wheel Nuts

5/8" - 18



**GL-0056**  
**Hex:** 1"  
**Height:** 21/32"  
**Degree:** 90  
**Plating:** Zinc

M10 - 1.25



**GL-0596**  
**Hex:** 21mm  
**Height:** 1.4"  
**Degree:** 60  
**Plating:** Chrome

M12 - 1.25



**GL-0064**  
**Hex:** 19mm  
**Height:** 16mm  
**Degree:** 60  
**Plating:** Zinc



**GL-0065**  
**Hex:** 21mm  
**Height:** 16mm  
**Degree:** 60  
**Plating:** Zinc



**GL-0500**  
**Hex:** 19mm  
**Height:** 1.4"  
**Degree:** 60  
**Plating:** Chrome  
**Bulge**



**GL-0508**  
**Hex:** 21mm  
**Height:** 1.4"  
**Degree:** 60  
**Plating:** Chrome  
**Bulge**



**GL-0099**  
**Hex:** 21mm  
**Height:** 1.4"  
**Degree:** 60  
**Plating:** Chrome

M12 - 1.5



**GL-0062**  
**Hex:** 19mm  
**Height:** 14mm  
**Degree:** 60  
**Plating:** Zinc



**GL-0063**  
**Hex:** 19mm  
**Height:** 23mm  
**Degree:** 60  
**Plating:** Zinc



**GL-0066**  
**Hex:** 21mm  
**Height:** 16mm  
**Degree:** 60  
**Plating:** Zinc



**GL-0072**  
**Hex:** 21mm  
**Height:** 18mm  
**Degree:** 60  
**Plating:** Zinc

### Did You Know?

We can manufacture "special" fasteners to meet your needs.\*

\*minimum quantity required.

## Wheel Nuts

M12 - 1.5



**GL-0085**  
**Hex:** 19mm  
**Height:** 22mm  
**Plating:** Zinc



**GL-0109**  
**Hex:** 19mm  
**Height:** 30mm  
**Degree:** 60  
**Plating:** Zinc



**GL-0506**  
**Hex:** 19mm  
**Height:** 1.4"  
**Degree:** 60  
**Plating:** Chrome  
**Bulge**



**GL-0509**  
**Hex:** 21mm  
**Height:** 1.4"  
**Degree:** 60  
**Plating:** Chrome  
**Bulge**



**GL-0100**  
**Hex:** 21mm  
**Height:** 1.4"  
**Degree:** 60  
**Plating:** Chrome

M14 - 1.5



**GL-0512**  
**Hex:** 21mm  
**Height:** 1.4"  
**Degree:** 60  
**Plating:** Chrome  
**Bulge**



**GL-0110**  
**Hex:** 7/8"  
**Height:** 20mm  
**Degree:** 60  
**Plating:** Zinc



**GL-0115**  
**Hex:** 22mm  
**Height:** 28.5mm  
**Degree:** 60  
**Plating:** Zinc



**GL-0309**  
**Hex:** 21mm  
**Height:** 16mm  
**Degree:** 60  
**Plating:** Zinc



**GL-0427**  
**Hex:** 21mm  
**Height:** 1.4"  
**Degree:** 60  
**Plating:** Stainless Cap









**GL-0428**  
**Hex:** 21mm  
**Height:** 1.7"  
**Degree:** 60  
**Plating:** Stainless Cap





### Did You Know?

We have served the Automotive After-market for over 20 years. Thanks for your support!

## Inner Cap Nuts for Steel & Aluminum Wheels

Standard Inner Cap Nut for Dual Steel Wheels	GLP Part Number	Replaces	Outer Thread	Inner Thread	Overall Length
 RH = GL-1001 LH = GL-1002	<b>GL-1001/2</b> Grade 8.2 Yellow Dichromate	Budd - 10708/9 Dayton - 13-3005R/L BWP - M128/9 Euclid - 7895R/L Leland - W694/5	1-1/8"-16	3/4"-16	2-7/32"
Standard for Steel Inner & Aluminum Outer Wheel Combinations  RH = GL-1003 LH = GL-1004	<b>GL-1003/4</b> Grade 8.2 Yellow Dichromate	Budd - 35336/7 Dayton - 13-3028R/L BWP - M130/1 Euclid - 7896R/L Leland - W620/1	1-1/8"-16	3/4"-16	2-9/16"
Longer Inner Nut for Steel Inner & Aluminum Outer Wheel Combinations  RH = GL-1005 LH = GL-1006	<b>GL-1005/6</b> Grade 8.2 Yellow Dichromate	Budd - 22621/2 Dayton - 13-3029R/L BWP - M132/3 Euclid - 7897R/L Leland - W107/8	1-1/8"-16	3/4"-16	3-1/16"
Heavy Duty Off-Highway Applications  RH = GL-1007 LH = GL-1008	<b>GL-1007/8 (Off-Highway)</b> Grade 8.2 Yellow Dichromate	Budd - 49414/5 Dayton - 13-3010R/L BWP - M140A/B Euclid - 7898R/L Leland - W160/1	1-5/16"-12	15/16"-12	3"
Metric Wheel Nut Applications  RH = GL-1009 LH = GL-1010	<b>GL-1009/10 (Metric)</b> For Hino & Isuzu Yellow Dichromate	Dayton - 13-3130R/L Hino - 9004-23101/24101 Euclid - 10253R/L Isuzu - 1-42335/6 Leland - W720/1 Navistar - 43212Z5025R/L	M30-1.5	M20-1.5	M-62 (2-7/16")
Inner Cap Nut for Dual Aluminum Wheels  RH = GL-1011 LH = GL-1012	<b>GL-1011/12</b> Grade 8.2 Yellow Dichromate	ALCOA - 5988R/L Dayton - 13-3026R/L BWP - M2400/1 Euclid - 5988R/L Leland - W486/7	1-1/8"-16	3/4"-16	3-1/16"

## Outer Cap Nuts for Dual Mounted Wheels

Standard Outer Nut for Dual Wheels	GLP Part Number	Replaces	Inner Thread	Hex	Height
	<b>(R.H.) GL 2001</b> <b>(L.H.) GL 2002</b> Grade 8 Yellow Dichromate	Dayton - 13-3012 R/L BWP - M126/7 Euclid - 5977 R/L Leland - W746/7	1-1/8"-16	1-1/2"	7/8"
1" High Outer Nut for Wide Based Aluminum Wheels 	<b>(R.H.) GL-2021</b> <b>(L.H.) GL-2022</b> Grade 8 Yellow Dichromate	Dayton - 13-3055 R/L Euclid - 5996 R/L Leland - W508/9	1-1/8"-16	1-1/2"	1"
Special Heavy Duty Nut for "Off Highway" Wheels 	<b>(R.H.) GL-2005</b> <b>(L.H.) GL-2006</b> Grade 8 Yellow Dichromate	Budd - 67011/2 Dayton - 13-3019 R/L BWP - M140G/H Euclid - 6060 R/L Leland - W426/7	1-1/8"-16	1-3/4"	1"
Heavy Duty for "Off-Highway" Applications 	<b>(R.H.) GL-2007</b> <b>(L.H.) GL-2008</b> Grade 8 Yellow Dichromate	Budd - 49416/7 Dayton - 13-3017R/L BWP - M140E/F Euclid - 5576 R/L Leland - W154/5	1-5/16"-12	1-3/4"	1-3/8"
Metric Wheel Nut Applications 	<b>(R.H.) GL-2009</b> <b>(L.H.) GL-2010</b> For Hino & Isuzu Yellow Dichromate	Dayton - 13-3131R/L Hino - 9004-21112/22104 Euclid - 10254 R/L Isuzu - 1-42333-023-R/L Leland - W722/3 Navistar - 433241 Z 5025 R/L	M30-1.5	M41	M25
Heavy Duty Outer Nut for Severe Service 	<b>(R.H.) GL-2013</b> <b>(L.H.) GL-2014</b> Grade 8 Yellow Dichromate	BUDD - 69912/3 Dayton - 13-3016 R/L BWP - M166/7 Euclid - 5579 R/L Leland - W115/6	1-1/8"-16	1-1/2"	1-1/8"









## Outer Cap Nuts for Single Mounted Wheels

Standard Cap Nut for Single Wheels	GLP Part Number	Replaces	Inner Thread	Hex	Height
	(R.H.) GL 2101 (L.H.) GL 2102	Budd - 37888/9 Dayton - 13-3013 R/L BWP - M124/5 Euclid - 5652 R/L Leland - W15/6	3/4"-16	1-1/2"	7/8"
For ALCOA Wide Base Aluminum Wheels Long & Short Pilot	<b>Long Pilot</b> (R.H.) GL-2103 (L.H.) GL-2104	ALCOA - 5995 R/L Dayton - 13-3055 R/L Euclid - 5995 R/L Leland - W508/9	3/4"-16	1-1/2"	1-3/8"
	<b>Short Pilot</b> (R.H.) GL-2123 (L.H.) GL-2124	ALCOA - 5554 R/L Budd - 70613/14 Euclid - 5554 R/L Leland - W122/3	3/4"-16	1-1/2"	1"
Heavy Duty Single Nut for Severe Service	(R.H.) GL-2105 (L.H.) GL-2106	Budd - 71736/7 Dayton - 13-3015 R/L BWP - M164/5 Euclid - 5578 R/L	3/4"-16	1-1/2"	1"
Heavy Duty for "Off-Highway" Applications	(R.H.) GL-2107 (L.H.) GL-2108	Budd - 76635/6 BWP - M140J/K Euclid - 5863 R/L Leland - W228/9	15/16"-12	1-3/4"	1-3/8"



## One Piece Flange Nuts

	<b>GL-2200</b>		M14-1.5	M22	M16	
	<b>GL-2201</b>	Budd - 64186 GMC - 3988631	Euclid - 5892	9/16"-18	7/8"	5/8"
	<b>GL-2202</b>	Gunitite - 45681 GMC - 3771410	Budd - 81269 Euclid - 5734	11/16"-16	1-1/8"	1-1/16"
	<b>GL-2203</b>	Dayton - 13-3047R Euclid - 9022R BWP - M1266	Budd - 95188 Dodge - 3637720	5/8"-18 R.H.	1-1/8"	1-1/16"
	<b>GL-2204</b>	Dayton - 13-3047L Euclid - 9022L BWP - M1267	Budd - 95189 Dodge - 3637719	5/8"-18 L.H.	1-1/8"	1-1/16"

## Two Piece Flange Wheel Nuts

	GLP Part Number	Replaces	Inner Thread	Hex	Height
For Uni-Mount 10 Hole Systems 	<b>GL-2301</b>	Budd - 106333 Dayton - 13-3052 BWP - M3203 Euclid - 6000 Leland - W498	M22 - 1.5	M33	M32
For Motor Wheel 8 Hole Systems 	<b>GL-2302</b>	Motor Wheel - 88881 Dayton - 13-3050 BWP - M3207 Euclid - 5991 Leland - W492	M22 - 1.5	M38	M35
Flange Nut Ford 	<b>GL-2303</b>	Alcoa - 389927 Ford - E4TZ-1012A Dayton - 13-3053 Euclid - 10234 Leland - W618	9/16"-18	1-1/16"	1-1/64"
Flange Nut M20 	<b>GL-2305</b>	GM - 15642921 Volvo - 947971-8 Ford - EHZ-1120 B Dayton - 13-3114 Euclid - 10235 Leland - W619	M20-1.5	M30	M26
	<b>GL-2306</b>	Euclid - 5708 Motor Wheel - 08434 Leland - W234	3/4"-16	1-3/16"	1-1/8"
	<b>GL-2307</b>		3/4"-16	1-5/16"	7/8"
	<b>GL-2308</b>	Utility Trailer - 129378 Quality Trailer - 09065114	3/4"-16	1-1/2"	7/8"

## Flange Wheel Nuts for Aluminum Wheels

	GLP Part Number	Replaces	Inner Thread	Hex	Height
	<b>GL-2304</b>	Alcoa - 39575	9/16"-18	15/16"	1-1/8"
	<b>GL-2227</b> Low Profile	Alcoa - 39874 Dayton - 13-3057 Euclid - 9020 Leland - W525 GMC - 2071619 Ford - E6HZ 1120A Accuride - 50125	M22-1.5	M33	M27
	<b>GL-39946</b> Teflon Coated	Alcoa - 39946 Dayton - 13-3051 Euclid - 10233 S/B - 102333 Leland - W749	5/8"-18	1-1/16"	13/16"

## Flange Wheel Nuts for Alcoa Wheels

	<b>GL-139698</b>	Alcoa - 139698	M14 - 1.5	27 mm	22 mm
	<b>GL-139987</b>	Alcoa - 139987	9/16"-18	1 1/16"	7/8"
 Front Bus Wheels	<b>GL-430632</b> <b>GL-578632</b> (Dacromet Coated)	Alcoa - 430632 Alcoa - 578632 (Dacromet Coated)	M22 - 1.5	33 mm	50 mm (2")
 Rear Bus Wheels	<b>GL-430732</b> <b>GL-578732</b> (Dacromet Coated)	Alcoa - 430732 Alcoa - 578732 (Dacromet Coated)	M22 - 1.5	33 mm	78 mm (3")

## Skirt Nut®

	GLP Part Number	Replaces	Inner Thread	Hex	Height
	<b>GL-2900</b>	All Style M22 Flange Nuts on Hub-Piloted Wheels	M22-1.5	33 mm	35 mm

## Sleeve Nuts

	GLP Part Number	Recommended Use	Inner Thread	Hex	Sleeve Length
	<b>GL-2906</b>	Steel - Steers	M22-1.5	33 mm	6 mm
	<b>GL-2919</b>	Aluminum - Steers Steel/Steel - Drives Steel Outer/Alum. Inner - Drives	M22-1.5	33 mm	19 mm
	<b>GL-2928</b>	Heavy Duty Aluminum Super Single - Wide Base Alum. Outer/Steel Inner - Drives	M22-1.5	33 mm	28 mm
	<b>GL-2939</b>	Dual Aluminum	M22-1.5	33 mm	39 mm

## Spoke Wheel Studs and Nuts

### Locking Back Nuts for Shoulder Studs



GLP Part Number	Thread Size	Similar to	
<b>GL-2408</b>	3/4" - 16	Budd 41073-7 Euclid 4961	BWP M-2459 Leland W451
<b>GL-2431</b>	7/8" - 14	Budd 41073-8 Euclid 1835	BWP M1255 Leland W-232
<b>GL-2445</b>	1" - 14	Budd 44672-9 Euclid 1828	BWP M1268 NWRA X-1445

### Rim Studs for Cast Spoke Wheels

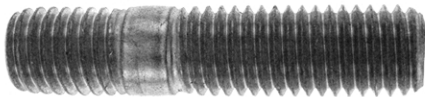

GLP Part Number	Size	Similar to	
<b>GL-3001</b>	5/8"-11 x 2-3/4"	Euclid 4958 Dayton 13-6002 BWP M-38	Leland W-5 Webb 161127
<b>GL-3002</b>	3/4"-10 x 3"	Dayton 13-6003 BWP M-39 Euclid 4956A	Leland W-6 GMC 2266639
<b>GL-3003</b>	3/4"-10 x 3-1/8"	Dayton 13-6008 Leland W-246 BWP M-1102	Euclid 5706 Webb 171027

### Rim Nuts for Cast Spoke Wheels

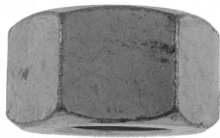

GLP Part Number	Size	Similar to	
<b>GL-3004</b>	5/8"-11"	Euclid 4962 Dayton 13-8003 BWP M-43	Leland W-5 Webb 161127
Grade 5 <b>GL-3005</b>	3/4"-10	Euclid 4963 Dayton 13-8004 BWP M-45	Leland W-8 Webb 74710
Grade 8 <b>GL-3006</b>	3/4"-10 Yellow	Euclid E-7775 Dayton 13-8006	Gunite W-854 Leland W-748
Grade 8 <b>GL-3006B</b>	3/4"-10 Black		

## Spoke Wheel Rim Clamps

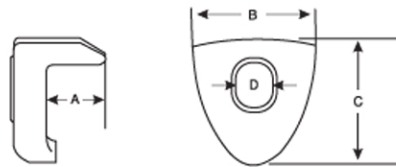

Use These Dimensions  
in Measuring Clamps

### Dayton "F" Style Wheel Clamps



GLP Part Number	Similar to	A	B	C	D
<b>GL-3096</b>	Euclid 5571A Leland W-3 Dayton 13-4002 Erie E-2 BWP M-3	1 1/8"	2 7/8"	2 1/2"	3/4"
<b>GL-3097</b>	Dayton 13-4006 Leland W-4 BWP M-4 Erie E-1 Euclid 5572A	1 3/4"	2 7/8"	2 1/2"	3/4"
<b>GL-3098</b>	Dayton 13-4004 Leland W-120 BWP M-8 Erie E-3 Euclid 5040A	1 1/2"	2 7/8"	2 1/2"	3/4"

## Oil Seal Hubcaps & Accessories

### Bolt-On Hubcaps & Accessories



GLP Part Number	Description	Similar to
<b>GL-4009</b>	Standard 6 Hole Bolt-on Cap w/Drain Plug	Stemco 340-4009 Stemco 340-4010

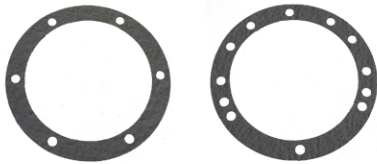

GLP Part Number	Description	Similar to
<b>GL-4012</b>	Standard 6 Hole Gasket	Stemco 330-3009
<b>GL-4013</b>	Universal Gasket (5 or 6 Holes)	Stemco 330-3067

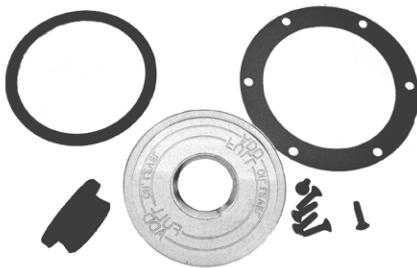

GLP Part Number	Description	Similar to
<b>GL-4020</b>	Window Kit - Includes Window, Screws, Plug, Inner Seal	Stemco 359-5995



GLP Part Number	Description	Similar to
<b>GL-4975</b>	Vented Rubber Plug for Bolt-on Caps	Stemco 359-5990



GLP Part Number	Description	Similar to
<b>GL-4205</b>	6 Hole Grease Hubcap	Euclid 975      Dana M10HK129 BWP M767      Dayton 09-005205

### Screw-On Hubcaps & Accessories



GLP Part Number	Description	Similar to
<b>GL-4913</b>	Fruehauf/Propar Type Includes O-ring & Side Plug	Stemco 340-4075    Euclid 04075 Fruehauf ACC7538-900

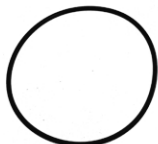

GLP Part Number	Description	Similar to
<b>GL-4974</b>	O-ring for Screw-on Caps	Stemco 330-3077    Euclid 05500 Fruehauf AXA-0484-1



GLP Part Number	Description	Similar to
<b>GL-4975</b>	Vented Rubber Plug for Screw-on Caps	Euclid 04000 Fruehauf AXA-1005-1

## Trailer King Pins & Locks



GLP Part Number	Description	Similar to
<b>GL-5000</b>	Standard Weld-on 8" King Pin 3/8" Plate, Hi-Tensile Alloy Steel	Holland KP-T-809F BWP M-698 Dana 13-101 Euclid E-700 BATCO 11-0212 Leland L-345



GLP Part Number	Description	Similar to
<b>GL-5030</b>	King Pin Lock	BATCO 11-0198 Euclid E-702A BWP M-770 Holland GL030-3010

## Drive Flange Wedges & Drive Flange Gaskets

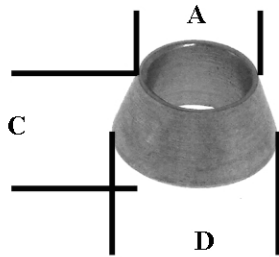

GLP Part Number	A	B	C	Similar to
<b>GL-5401</b>	7/16	3/4	13/32	Euclid E5737
<b>GL-5403</b>	7/16	11/16	13/32	Euclid E5952
<b>GL-5405</b>	1/2	13/16	13/35	Euclid E5740
<b>GL-5406</b>	1/2	7/8	15/32	Euclid E5957
<b>GL-5408</b>	5/8	1	15/32	Euclid E5743
<b>GL-5409</b>	5/8	1	9/16	Euclid E5960

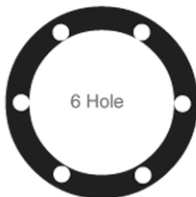

GLP Part Number	Similar to	Holes	O.D.	I.D.	Bolt Circle	Bolt Size
<b>GL-9029</b>	Euclid E-2432 Leland L-1502 Dayton 13-7123 BWP M-2530	8	5 9/16"	4"	4 3/4"	7/16"
<b>GL-9019</b>	Euclid E-2436 Leland L-1507 Dayton 13-7106	8	6 7/16"	4"	5 1/2"	5/8"
<b>GL-9021</b>	Euclid E-2437 Leland L-1505 Dayton 13-7110 BWP M-2531	12	6 1/16"	4 1/2"	5 1/4"	1/2"
<b>GL-9020</b>	Euclid E-2433 Leland L-1504 Dayton 13-7108 BWP M-2532	8	6 1/8"	4 1/2"	5 9/32"	1/2"
<b>GL-9022</b>	Euclid E-2438 Leland L-1506 Dayton 13-7112 BWP M-2533	12	6 1/2"	5"	5 11/16"	7/16"
<b>GL-9023</b>	Euclid E-2340 Leland L-1508 Dayton 13-7114 BWP M-2535	12	7 7/16"	5 11/16"	6 9/16"	1/2"
<b>GL-9024</b>	Euclid E-2435 Leland L-1509 Dayton 13-7116 BWP M-2536	8	8 3/8"	5 3/4"	7"	5/8"
<b>GL-9025</b>	Euclid E-10238 Dayton 13-7118	6	8 1/2"	6 7/16"	7 7/16"	11/16"
<b>GL-9026</b>	Euclid E-2434 Leland L-1791 Dayton 13-7119	8	7 3/8"	5 3/8"	6 3/8"	9/16"
<b>GL-9027</b>	Euclid E-2431 Leland L-1511 BWP M-2534	8	8 1/2"	5 5/8"	7"	3/4"
<b>GL-9028</b>	Euclid E-10237 Leland L-2956 Dayton 13-7122	8	6"	4 5/16"	5 1/8"	1/2"
<b>GL-9030</b>	Euclid E-2341 Leland L-1510 BWP M-2537	8	8 1/4"	6"	7"	5/8"

## Truck Wheel Guards

Wheel Guards are nylon separator plates that are approximately .03" thick. They are placed between the hub or drum and the wheel, and between two wheels on a dual wheel application. The Wheel Guard is highly recommended for all applications and all combinations of Aluminum and Steel wheels.

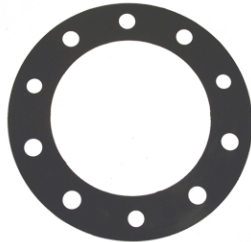
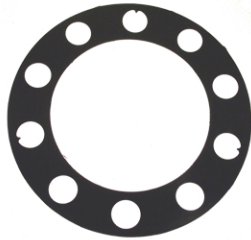

GLP Part Number	Application	Holes	Bolt Circle	I.D.
<b>GL-5901</b>	For wheels using 1-1/8" and 7/8" diameter studs (stud pilot wheels)	10	11 1/4"	8 13/16"
<b>GL-5902</b>	For wheels using 3/4" Diameter Studs (stud pilot wheels)	10	11 1/4"	8 13/16"
<b>GL-5903</b>	For wheels using 22 mm diameter studs "unimount" (hub pilot)	10	285.75 mm	8 13/16"
<b>GL-7902</b>	For wheels using 22 mm diameter studs "Motor Wheel" (hub pilot)	8	275 mm	8 13/16"
<b>GL-8482</b>	For GM and Dodge Trucks using 5/8" Diameter Studs	8	6 1/2"	4.82"
<b>GL-8525</b>	For Ford trucks using 5/8" diameter studs	8	6 1/2"	5.25"
<b>GL-8675</b>	For Ford trucks with 19.5" wheels using 5/8" diameter studs	8	225 MM	6.75"
<b>GL-7381</b>	For bus wheels with 22 mm diameter studs	10	335 MM	

### DiscMate™ Wheel Protector for Alcoa wheels

GLP Part Number	Application	Holes	Bolt Circle
<b>GL-18000</b> (Alcoa 018000)	For wheels using 32 mm sleeved cap nut (hub pilot)	10	335 mm



## Sockets

**S-2413 Nut & Stud Remover Kit** For Disc & Spoke Wheels  
(Requires 1 1/2" Socket)



**Includes:**

- Drive On Tool
- 13/16" Insert (Removes Broken 1 1/8" Inner Nut)
- 3/4" Insert Stud Remover
- 5/8" Insert Stud Remover

*Items can be purchased separately*

**S-2515 Broken Inner Nut Remover**  
(Requires 1 1/2" Socket)



One Piece Tool For Removing Broken  
Or Stripped Inner Cap Nuts

**Stud Setter** For Spoke Wheels  
(Requires 1 1/4" Socket)



**S-2616 Installs 5/8"-11 Wheel Studs**  
**S-2617 Installs 3/4"-10 Wheel Studs**

### Deep Length Impact Sockets

	Drive	Hex	A	B	C	D	E
<b>S-4033MD</b>	1"	33mm	52	53	62	40	90
<b>S-3033MD</b>	3/4"	33mm	52	53	62	40	90

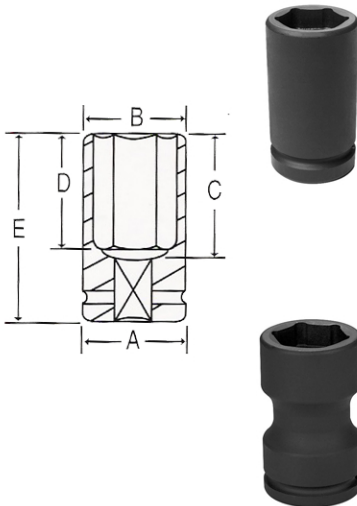

### Combination Budd Wheel Impact Sockets

	Drive	Hex	Square	A	B	C	D	E
<b>S-4223C</b>	1"	1 1/2	13/16	2.24	2.24	1.58	.55	90
<b>S-3223C</b>	3/4"	1 1/2	13/16	2.24	2.24	1.58	.55	90

Removes and installs Budd style wheel nuts. Sockets have two openings, 1 1/2" hex for outer nut and 13/16 square for the inner nut. This Eliminates the need for two separate sockets.

## Brake Drum Bolts & Components

### Drum Bolt Assembly (Grade 8) - Bolt, Nut & Washer

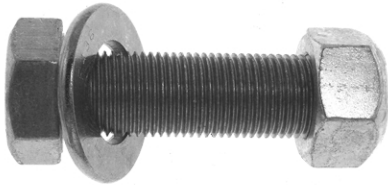

GLP Part Number	Size	Similar to
GL-6012	5/8"-18 x 2"	Euclid E5970
GL-6013	5/8"-18 x 2 1/4"	
GL-6014	3/4"-16 x 2"	Euclid E5972
GL-6015	3/4"-16 x 2 1/2"	
GL-6016	3/4"-16 x 2 1/4"	

### Bolts (Grade 8)

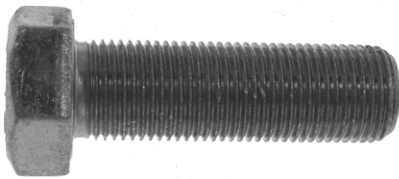

GLP Part Number	Size	Similar to
GL-6017	5/8"-18 x 2 1/4"	
GL-6019	3/4"-16 x 2 1/4"	
GL-6020	5/8"-18 x 2"	Dayton 08-201140 Euclid 5966 Gunitite WP-451 BATCO 13-6521 Webb 86222 BWP M-2454
GL-6021	3/4"-16 x 2"	Dayton 08-201500 Euclid 5968 Gunitite WP-845 BATCO 13-6523 BWP M-2456
GL-6022	3/4"-16 x 2 1/2"	

### Top Locknuts (Grade 8)



GLP Part Number	Size	Similar to
GL-6023	5/8"-18	Dayton 08-201931 Euclid 1943 BATCO 13-6561 BWP M-2457
GL-6024	3/4"-16	Dayton 08-201932 Euclid 2230 BATCO 13-6563 BWP M-2459

### Flat Washer (Grade 8)



GLP Part Number	Size	Similar to
GL-6025	5/8"	Euclid 2547 BATCO 13-6570
GL-6026	3/4"	Euclid 2545 BATCO 13-6571

## Spring Shackle Bolts & Locknuts



GLP Part Number	Description
GL-6030	9/16"-18 x 3" Spring Shackle Bolt

GLP Part Number	Description
GL-6040	9/16"-18 Center Locking Nut (Reversible)
GL-6045	9/16"-18 Top Lock Nut (Non-reversible)

## Mobile Home/Trailer Wheel Bolts & Clamps



GLP Part Number	Size	Similar to
GL-6100	1/2"-20 x 7/8"	Universal Trailer Hub Bolt, 60 degree Taper
GL-6115	Kelsey 79954	Universal Mobile Home Clamp

## Tire Balancing Beads

Automatic - Self Adjusting Wheel Balancing

*Counteract* - the "PREMIER" manufacturer of "Balancing Beads"



**(Bag-in-Bag Installation Method)**

Now it's as easy as 1...2...3!

**Counteract Balancing Beads** is now offering a "Bag in Bag" packaging. The tire installer simply opens the outer bag and throws the inner bag directly into the tire cavity. This method is highly preferred by tire installers and was specifically developed for use with the air-blasting tool to seat the tire on the rim. This is a real time saver as it eliminates the necessity to use an application pump. The ultra light throw in bag will "burst" with the increasing P.S.I. inside the tire, which releases the CBB.

**Contact us -**

**for a complete "package" of information about "Balancing Beads"  
Including an application chart, price list  
and a sample packet of "Balancing Beads"**

## Valve Cores, Caps & Tools

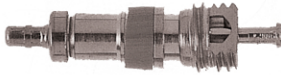

### GL-7001

#### Valve Core

Standard Bore Heat Resistant  
Fits Cars, Trucks & Buses  
(Replaces Shrader 5405V)

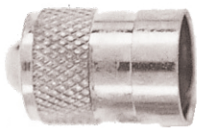

### GL-7003

#### Valve Cap

Standard Metal Dome Valve Cap  
With Rubber Seal  
(Replaces Shrader 7572V)



### GL-7008

#### Valve Cap

Standard Plastic Dome Valve Cap  
  
(Replaces Shrader 660V)

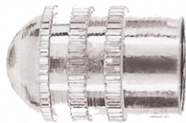

### GL-7012

#### Heavy Duty Valve Cap

Heavy Duty Dome Type Cap for Trucks  
Features Heat Resistant Sealing Washer  
(Replaces Shrader 440V)

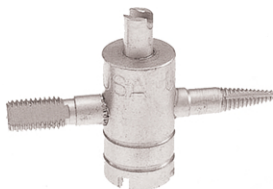

### GL-7061

#### Standard Bore 4-Way Valve Tool

Repairs and Reconditions Inside and Outside  
Valve Threads also Inserts and Removes Cores  
(Replaces Shrader 3522)



### GL-7085

#### Core Installation Tool

One End Fits Large Bore Cores  
Other End Fits Standard Bore Cores

## Air Gauges



### GL-7105

#### Passenger Tire Pencil Style Gauge

1 PSI Measuring Increments 10-50 PSI Reading  
Chrome Finish  
(Replaces Shrader 7760A)



### GL-7115

#### Truck High Pressure Pencil Style Gauge

2 PSI Measuring Increments 20-120 PSI Reading  
Chrome Finish  
(Replaces Shrader 8101A)



### GL-7130

#### Dual Foot Truck High Pressure Gauge Angled

2 PSI Measuring Increments 20-120 PSI Reading  
Chrome Finish  
(Replaces Shrader 8102A)



### GL-7135

#### Dual Foot Truck Service Gauge Angled

2 PSI Measuring Increments 20-150 PSI Reading  
Chrome Finish  
(Replaces Shrader 1250A)



### GL-7150

#### Dual Foot Truck High Pressure Gauge Straight On & 30 Degree

2 PSI Measuring Increments 20-120 PSI Reading  
Chrome Finish



### GL-7155

#### Dual Foot Truck Service Straight & 30 Degree

2 PSI Measuring Increments 10-150 PSI Reading  
Chrome Finish  
(Replaces Shrader 7188L)



### GL-7185

#### Special Dual Foot Truck Service Straight & 30 Degree

2 PSI Measuring Increments 10-150 PSI Reading  
Chrome Finish

## Air Chucks



**GL-7305**  
**Ball Foot Air Chuck**  
 3/4" Hex Brass with 1/4" NPT Female Thread  
 (Replaces Shrader 5499)



**GL-7315**  
**Ball Foot Air Chuck with Clip**  
 3/4" Hex Brass with 1/4" NPT Female Thread Heavy Duty Spring Holds Chuck onto Valve While Inflating  
 (Replaces Shrader 6739)



**GL-7318**  
**Chuck Clip**  
 Heavy Duty Spring Clip  
 Attaches To Chuck #GV-7305  
 (Replaces Shrader 6529)



**GL-7330**  
**"Lock-On" Dual Air Foot Chuck**  
 Straight & 30° Reverse Angle Chuck  
 1/4" NPT Female Thread, 6" Overall Length  
 (Replaces Shrader 9994L)



**GL-7335**  
**45° Angle Dual Foot Air Chuck**  
 For Hard to Reach Dual Wheels  
 1/4" NPT Female Thread, 6" Overall Length  
 (Replaces Shrader 8159B)



**GL-7340**  
**"Lock On" Air Chuck**  
 Locks on Valve When Sleeve is Pushed Forward  
 1/4" NPT Female Thread  
 (Replaces Shrader 5265)

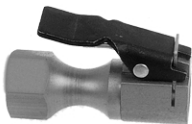

**GL-7360**  
**"Clip On" Air Chuck**  
 European Style Air Chuck  
 1/4" NPT Female Thread



**GL-7370**  
**"Lock On" Dual Foot Air Chuck**  
 Straight and 180° Reverse Angle Chuck  
 1/4" NPT Female Thread, 6" Overall Length

## Hubodometers



**GL-8000**  
(And Specify Tire Size)

**GL-8016**  
Universal Mounting Bracket

**Our dependable Hubodometers are quality tested for your satisfaction and have the following benefits:**

- The unit is built for rough use on the highway
- Large easy to read numbers for accurate readings
- Records total mileage - forwards and backwards
- Will not "orbit" or spin and maintains stability over rough roads
- Pinion gears and bushings are designed for long trouble free life
- Polycarbonate cover resists breaking and allows easy reading
- Sealed to guard against moisture, road hazards and tampering



# Part Number Interchange

Alcoa	Great Lakes Parts	DAYTON PARTS/Batco	Great Lakes Parts	DAYTON PARTS/Batco	Great Lakes Parts
5552-R	GL-2001	11-0670	GL-4913	11-1986	GL-5980
5552-L	GL-2002	11-0671	GL-4964	11-1987	GL-5985
5554-L	GL-2124	11-0673	GL-4069	11-1993	GL-5991
5554-R	GL-2123	11-0674	GL-4010	11-1994	GL-5992
5977-R	GL-2003	11-0675	GL-4020	11-1995	GL-5993
5977-L	GL-2004	11-0676	GL-4021	13 3017-L	GL-2008
5988-R	GL-1011	11-0677	GL-4009	13-3002	GL-2205
5988-L	GL-1012	11-0680	GL-4974	13-3004	GL-2202
5995-R	GL-2103	11-0681	GL-4975	13-3005-L	GL-1002
5995-L	GL-2104	11-1901	S-1901	13-3005-R	GL-1001
7896-R	GL-1003	11-1902	S-1902	13-3007-L	GL-1006
7896-L	GL-1004	11-1903	S-1903	13-3007-R	GL-1005
		11-1904	S-1904	13-3008-L	GL-1004
		11-1905	S-1905	13-3008-R	GL-1003
		11-1906	S-1906	13-3010-I	GI-1008
		11-1907	S-1907	13-3010-R	GL-1007
		11-1908	S-1908	13-3011	GL-2408
		11-1909	S-1909	13-3012-L	GL-2002
		11-1910	S-1910	13-3012-R	GL-2001
		11-1911	S-1911	13-3013-L	GL-2102
		11-1912	S-1912	13-3013-R	GL-2101
		11-1913	S-1913	13-3015-L	GL-2106
		11-1914	S-1914	13-3015-R	GL-2105
		11-1915	S-1915	13-3016-L	GL-2014
		11-1916	S-1916	13-3016-R	GL-2013
		11-1917	S-1917	13-3017-R	GL-2007
		11-1918	S-1918	13-3019-L	GL-2006
		11-1919	S-1919	13-3019-R	GL-2005
		11-1920	S-1920	13-3026-L	GL-1012
		11-1921	S-1921	13-3026-R	GL-1011
		11-1922	S-1922	13-3028-L	GL-1004
		11-1923	S-1923	13-3028-R	GL-1003
		11-1924	S-1924	13-3029-L	GL-1006
		11-1925	S-1925	13-3029-R	GL-1005
		11-1926	S-1926	13-3040R	GL-0016
		11-1927	S-1927	13-3042R	GL-0055
		11-1928	S-1928	13-3043R	GL-0027
		11-1932	S-1932	13-3044	GL-0058
		11-1933	S-1933	13-3046	GL-0052
		11-1934	S-1934	13-3047-L	GL-2204
		11-1935	S-1935	13-3047-R	GL-2203
		11-1936	S-1936	13-3048	GL-2201
		11-1937	S-1937	13-3050	GL-2302
		11-1939	S-1938	13-3052	GL-2301
		11-1954	S-1940	13-3053	GL-2303
		11-1960	GL-5962	13-3054-L	GL-2104
		11-1963	GL-5961	13-3054-R	GL-2103
		11-1968	GL-5950	13-3055L	GL-2022
		11-1969	GL-5969	13-3055R	GL-2021
		11-1976	GL-5970	13-3130-L	GL-1010

A.P.T.	Great Lakes Parts
F-022	GL-3222
F-399	GL-3083
FF-142	GL-3263
FF-274	GL-3244
FF-275	GL-3243
FF-295	GI-3087
FF-853	GL-3085
R-053	GL-3099
R-123	GL-3096
R-125	GL-3125
R-229	GL-3116
R-235	GL-3097
R-256	GL-3112
R-257	GL-3113
R-302	GL-3114
R-314	GL-3298
R-518	GL-3101
R-584	GL-3257
R-708	GL-3103
R-709	GL-3104
R-993	GL-3098
RG-008	GL-3158
RG-110	GL-3256
RG-138	GL-3255
RG-562	GL-3162
RM-153	GL-3279
RM-156	GL-3270
RM-158	GL-3271

DAYTON PARTS/Batco	Great Lakes Parts
11-0198	GL-5030
11-0212	GL-5000
11-0620	GL-4913
11-0660	GL-4205





# Part Number Interchange

DAYTON PARTS/Batco	Great Lakes Parts
13-3130-R	GL-1009
13-3131-L	GL-2010
13-3131-R	GL-2009
13-4002	GL-3096
13-4004	GL-3098
13-4006	GL-3097
13-4008	GL-3099
13-4009	GL-3101
13-4010	GL-3103
13-4011	GL-3104
13-4311	GL-3105
13-4530	GL-3256
13-4531	GL-3255
13-4601	GL-3257
13-4702	GL-3271
13-4703	GL-3270
13-4704	GL-3279
13-4723	GL-3112
13-4724	GL-3113
13-4725	GL-3114
13-4807	GL-3298
13-4850	GL-3108
13-5001	GL-3294
13-5007	GL-3083
13-5012	GL-3085
13-5014	GL-3243
13-5015	GL-3244
13-5016	GL-3263
13-5020	GL-3087
13-6002	GL-3001
13-6003	GL-3002
13-6008	GL-3003
13-6521	GL-6020
13-6523	GL-6021
13-6561	GL-6023
13-6563	GL-6024
13-6570	GL-6025
13-6571	GL-6026
13-6581	GL-6012
13-6583	GL-6014
13-7150	GL-4013
13-7151	GL-4012
13-7202	GL-5401
13-7204	GL-5403
13-7208	GL-5405
13-7210	GL-5406
13-7216	GL-5408
13-7218	GL-5409
13-8003	GL-3004

DAYTON PARTS/Batco	Great Lakes Parts
13-8004	GL-3005
13-8006	GL-3006

Budd	Great Lakes Parts
10708	GL-1001
10709	GL-1002
22621	GL-1005
22622	GL-1006
35336	GL-1003
35337	GL-1004
37888	GL-2101
37889	GL-2102
37891	GL-2001
37892	GL-2002
39388	GL-0016
40417	GL-0027
41073-7	GL-2408
41073-8	GL-2431
44672-9	GL-2445
49414	GL-1007
49415	GL-1008
49416	GL-2007
49417	GL-2008
64186	GL-2201
67011	GL-2005
67012	GL-2006
67147	GL-0055
67148	GL-0056
69912	GL-2013
69913	GL-2014
70613	GL-2123
70614	GL-2124
71736	GL-2105
71737	GL-2106
76635	GL-2107
76636	GL-2108
80521	GL-0014
81269	GL-2202
84608	GL-2205
88013	GL-1005
88014	GL-1006
95188	GL-2203
95189	GL-2204
106333	GL-2301
3203001	GL-1005
3203002	GL-1006
3203401	GL-1003
3203402	GL-1004

Budd	Great Lakes Parts
3203403	GL-1001
3203404	GL-1002

B.W.P.	Great Lakes Parts
M1052	GL-4913
M1102	GL-3003
M1105	GL-3114
M1122	GL-3085
M1123	GL-3103
M1124	GL-3104
M1125	GL-3099
M1127	GL-3270
M1134	GL-3257
M1141	GL-3112
M1142	GL-3113
M1153	GL-2205
M1175	GL-3271
M1183	GL-3298
M124	GL-2101
M1242	GL-3255
M1243	GL-3256
M1249	GL-3279
M125	GL-2102
M1254	GL-2201
M1259	GL-3105
M126	GL-2001
M1266	GL-2203
M1267	GL-2204
M127	GL-2002
M128	GL-1001
M129	GL-1002
M130	GL-1003
M131	GL-1004
M132	GL-1005
M133	GL-1006
M134	GL-2123
M135	GL-2124
M136	GL-1011
M137	GL-1012
M138A	GL-2408
M140A	GL-1007
M140B	GL-1008
M140E	GL-2007
M140F	GL-2008
M140G	GL-2005
M140H	GL-2006
M140J	GL-2107
M140K	GL-2108





# Part Number Interchange

Erie Wheel	Great Lakes Parts	Euclid	Great Lakes Parts	Euclid	Great Lakes Parts
B-2	GL-3125	E1918	S-1918	E5740	GL-5405
E-1	GL-3097	E1919	S-1919	E5743	GL-5408
E-2	GL-3096	E1920	S-1920	E5747	GL-3257
E-3	GL-3098	E1921	S-1921	E5781	GL-3271
E-7	GL-3257	E1922	S-1922	E5783	GL-3270
E-12	GL-3103	E1923	S-1923	E5784A	GL-3103
E-22	GL-3101	E1924	S-1924	E5786	GL-3099
5259	GL-3002	E1925	S-1925	E5821	GL-3279
5260	GL-3005	E1926	S-1926	E5827	GL-3112
5302RH	GL-1001	E1927	S-1927	E5828	GL-3113
5303LH	GL-1002	E1928	S-1928	E5829	GL-3114
5304RH	GL-2001	E1936	S-1936	E5833	GL-5980
5305LH	GL-2002	E1943	GL-6023	E5834	GL-5985
5306RH	GL-2408	E2230	GL-6024	E5838	GL-3087
5312Rh	GL-1011	E2545	GL-6026	E5850	GL-5962
5313LH	GL-1012	E2547	GL-6025	E5854	GL-5969
5326RH	GL-2301	E3371	S-1938	E5855	GL-5950
		E4956A	GL-3002	E5856	GL-5961
		E4958	GL-3001	E5863L	GL-2108
		E4961A	GL-2408	E5863R	GL-2107
		E4962	GL-3004	E5877	GL-2431
		E4963	GL-3005	E5878	GL-2445
		E4975R	GL-0055	E5885	GL-3158
		E4976R	GL-0053	E5889	GL-3245
		E4979R	GL-0044	E5890	GL-3246
		E5040A	GL-3098	E5891	GL-3247
		E5205	GL-5990	E5892	GL-2201
		E5206	GL-5991	E5902	GL-3243
		E5207	GL-5992	E5904	GL-3255
		E5208	GL-5993	E5905	GL-3256
		E5552L	GL-2002	E5906	GL-3258
		E5552L	GL-2002	E5926	GL-3085
		E5552R	GL-2001	E5927	GL-3083
		E5552R	GL-2001	E5952	GL-5403
		E5554L	GL-2123	E5953	GL-3298
		E5554R	GL-2124	E5957	GL-5406
		E5571A	GL-3096	E5960	GL-5409
		E5572A	GL-3097	E5966	GL-6020
		E5576L	GL-2008	E5968	GL-6021
		E5576R	GL-2007	E5970	GL-6012
		E5578L	GL-2106	E5972	GL-6014
		E5578R	GL-2105	E5977L	GL-2004
		E5579L	GL-2014	E5977R	GL-2003
		E5579R	GL-2013	E5988L	GL-1012
		E5652L	GL-2102	E5988R	GL-1011
		E5652R	GL-2101	E5991	GL-2302
		E5704	GL-2205	E5995L	GL-2104
		E5733	GL-2408	E5995R	GL-2103
		E5734	GL-2202	E5996L	GL-2022
		E5737	GL-5401	E5996R	GL-2021

Euclid	Great Lakes Parts
E04000V	GL-4975
E04075H	GL-4964
E04075V	GL-4913
E05500	GL-4974
E10234	GL-2303
E10238	GL-9025
E10253L	GL-1010
E10253R	GL-1009
E10254L	GL-2010
E10254R	GL-2009
E1597A	S-1941
E1828	GL-2445
E1835	GL-2431
E1901	S-1901
E1902	S-1902
E1903	S-1903
E1904	S-1904
E1905	S-1905
E1906	S-1906
E1907	S-1907
E1908	S-1908
E1909	S-1909
E1910	S-1910
E1911	S-1911
E1912	S-1912
E1913	S-1913
E1914	S-1914
E1915	S-1915
E1916	S-1916
E1917	S-1917



# Part Number Interchange

Euclid	Great Lakes Parts
E6000	GL-2301
E6053	GL-3263
E6054	GL-3294
E6060L	GL-2006
E6060R	GL-2005
E700	GL-0345
E702	GL-5030
E7775	GL-3006
E7895L	GL-1002
E7895R	GL-1001
E7896L	GL-1004
E7896R	GL-1003
E7897L	GL-1006
E7897R	GL-1005
E7898L	GL-1008
E7898R	GL-1007
E844	S-1940
E9012L	GL-0059
E9012R	GL-0058
E9022L	GL-2204
E9022R	GL-2203
E9023	GL-3244
E9318	GL-2301
E9318	GL-2301
E975	GL-4205
E975	GL-4205
ES785	GL-3104

Firestone	Great Lakes Parts
NT-16	GL-3004
NT-17	GL-3005
NT-30	GL-2202
NTL-26	GL-2102
NTR-26	GL-2101
NTR-27	GL-1001

Ford	Great Lakes Parts
B4919X	GL-1001
BB1132	GL-1001
B4920X	GL-1002
BB1133	GL-1002
872331	GL-1007
872325	GL-1008
BB1135	GL-2002
BB1134	GL-2001
828437	GL-2007
872326	GL-2008
BB1120	GL-2101

Ford	Great Lakes Parts
BB1121	GL-2102
C3TZ1120A	GL-2205
E4TZ1012A	GL-2303
1199Q1811	GL-2014
1199R1812	GL-2013
356085S8B	GL-3004

Fruehauf	Great Lakes Parts
226604	GL-1007
226605	GL-1008
275340	GL-1011
275341	GL-1012
334816	GL-1003
334817	GL-1004
502282	GL-2408
534764	GL-2001
534765	GL-2002
534766	GL-1001
534767	GL-1002
534768	GL-2101
534769	GL-2102
535414	GL-3097
535588	GL-309C
535799	GL-3002
535860	GL-3001
535861	GL-3004
535885	GL-3005
535886	GL-3003
ACA8587	GL-1002
ACA8588	GL-2002
ACA85881	GL-2001
ACC6113900	GL-4964
ACC7538900	GL-4913
AXA-0484-1	GL-4974
AXA-1005-1	GL-4975
MWC-05995L	GL-2104
MWC-05995R	GL-2103
MWC-X02143	GL-2302
MMC-X02156	GL-2301

Goodyear	Great Lakes Parts
CL-27	GL-3223
CL-48	GL-3224
CL-49	GL-3225
CL-55	GL-3226
CL-81	GL-3227
CL-171	GL-3228
CL-301	GL-3229

Goodyear	Great Lakes Parts
CL-1008	GL-3108
CL-1022	GL-3222
GY-562	GL-3162
NV-30	GL-3005
NV-65	GL-3004
ST-68	GL-3001

GMC	Great Lakes Parts
2266639	GL-3002
2393267	GL-3097
3771410	GL-2202
3988631	GL-2201
5667139	GL-3096
5767140	GL-3098
279670	GL-2001
279671	GL-2002
279672	GL-1001
279673	GL-1002
644158	GL-3085
659535	GL-3004
790861	GL-3003
2000389	GL-3244
2011512	GL-3243
2016026	GL-3255
2066640	GL-3005
2162150	GL-3001
3729737	GL-2102
3729738	GL-2101
3735549	GL-2002
3735550	GL-2001
2202032	GL-2101
2202033	GL-2102
3778640	GL-3257

Gunite	Great Lakes Parts
25264	GL-2101
25265	GL-2102
34271	GL-2001
34272	GL-2002
36162	GL-1001
36163	GL-1002
45681	GL-2202
49748	GL-2205
W-855	GL-3003
W-984L	GL-2002
W515	GL-3245
W544	GL-3246
W545	GL-3247



# Part Number Interchange

Gunite	Great Lakes Parts
W866	GL-3258
W1038-L	GL-1002
W1038-R	GL-1001
W1110	GL-3256
W1138	GL-3255
W1165	GL-2302
W1338	GL-2301
WP- 2	GL-3004
WP-147	GL-3002
WP-148	GL-3005
WP-177	GL-3001
WP-267	GL-3257
WP-451	GL-6020
WP-722	GL-3243
WP-725	GL-3244
WP-845	GL-6020

Haltec	Great Lakes Parts
A10OVC-1	GL-7001
A10OVC-2	GL-7002
A10OVC-3	GL-7003
A10OVC-8	GL-7008
A10OVC-12	GL-7012
CH305	GL-7305
CH315	GL-7315
CH318	GL-7318
CH330LO	GL-7330
CH335	GL-7335
CH340	GL-7340
CH360	GL-7360
CH370LO	GL-7370
DS-1	GL-7021
GA105	GL-7105
GA120M	GL-7115
GA130	GL-7130
GA135	GL-7135
GA150	GL-7150
GA155	GL-7155
GA185	GL-7185
TL-610	GL-7061
TL-685	GL-7085

Holland	Great Lakes Parts
GL-030-3010	GL-5030
KP-T-809F	GL-5000

Hino	Great Lakes Parts
900421112	GL-2009
900422104	GL-2010
900423101	GL-1009
900424101	GL-1010

International	Great Lakes Parts
41419	GL-1001
54492R1	GL-3005
54493R2	GL-3096
54494R1	GL-3002
83155H	GL-2001
83156H	GL-2002
84711H	GL-2101
84712H	GL-2102
101731H1	GL-1001
101732H1	GL-1002
129302RL	GL-1006
129303R1	GL-1005
161075C1	GL-2302
189444R1	GL-3001
189445R1	GL-3004
283110C1	GL-4021
384102C1	GL-3087
386788C1	GL-3003
403961C1	GL-3256
424282R1	GL-2014
425283R1	GL-2013
431620R91	GL-4009
431621R1	GL-4012
437857C1	GL-2204
437858C1	GL-2203
446217R1	GL-3097
452010C1	GL-3294
472277C1	GL-3243
519386C1	GL-3244
590200C1	GL-1012
590201C1	GL-1011
698165R1	GL-1007
698166R1	GL-1008
698167R1	GL-2007
698168R1	GL-2008
878179R1	GL-2408
898375R1	GL-1005
898376R1	GL-1006
974745R1	GL-2006
974746R1	GL-2005
988339R1	GL-3103
3213851R1	GL-4205

Isuzu	Great Lakes Parts
1-42333023	GL-2009
1-42334023	GL-2010
1-42335005	GL-1009
1-42336005	GL-1010

Leland	Great Lakes Parts
L345	GL-5000
L454	GL-4205
L885	GL-4913
L1513	GL-5403
L1514	GL-5401
L1515	GL-5405
L1516	GL-5406
L1517	GL-5408
L1518	GL-5409
W- 3	GL-3096
W- 4	GL-3097
W- 5	GL-3001
W- 6	GL-3002
W- 7	GL-3004
W- 8	GL-3005
W-11	GL-1001
W-12	GL-1002
W-13	GL-2001
W-14	GL-2002
W-15	GL-2101
W-16	GL-2102
W-99	GL-2408
W105	GL-1011
W106	GL-1012
W107	GL-1005
W108	GL-1006
W110	GL-2408
W115	GL-2013
W116	GL-2014
W120	GL-3098
W122	GL-2123
W123	GL-2124
W124	GL-3083
W135	GL-3257
W154	GL-2007
W155	GL-2008
W158	GL-1003
W159	GL-1004
W160	GL-1007
W161	GL-1008
W182	GL-2202
W183	GL-2205
W184	GL-3114



# Part Number Interchange

Leland	Great Lakes Parts	Leland	Great Lakes Parts	Midland	Great Lakes Parts
W228	GL-2107	W660	GL-3960	67211	GL-2001
W229	GL-2108	W694	GL-1001	67212	GL-2002
W230	GL-055	W695	GL-1002	67213	GL-2101
W231	GL-0056	W709	GL-0052	67214	GL-2102
W232	GL-2431	W720	GL-1009	67266	GL-1007
W246	GL-3003	W721	GL-1010	67266	GL-1011
W256	GL-3243	W722	GL-2009	67267	GL-1012
W257	GL-3255	W723	GL-2010	67267	GL-1008
W258	GL-3256	W746	GL-2003	67268	GL-2013
W296	GL-1011	W747	GL-2004	67269	GL-2014
W297	GL-1012	W748	GL-3006	67272	GL-3098
W403	GL-3099	WT3	GL-5980	67279	GL-3257
W404	GL-3101	WT4	GL-5985	67287	GL-1003
W405	GL-3103	WT5	GL-5990	67288	GL-1004
W406	GL-3104	WT6	GL-5993	67293	GL-3114
W407	GL-3087	WT7	GL-5992	67391	GL-1011
W408	GL-3085	WT8	GL-5991	67392	GL-1012
W418	GL-3244			67905	GL-3085
W420	GL-3298			411655	GL-9013
W426	GL-2005				
W427	GL-2006				
W448	GL-3271				
W449	GL-3270				
W450	GL-3113				
W451	GL-2408				
W456	GL-3108				
W458	GL-2201				
W467	GL-3279				
W486	GL-1011				
W487	GL-1012				
W492	GL-2302				
W494	GL-3294				
W498	GL-2301				
W506	GL-2103				
W507	GL-2104				
W508	GL-2021				
W509	GL-2022				
W536	GL-3112				
W562	GL-6012				
W564	GL-6014				
W565	GL-3263				
W583	GL-0016				
W588	GL-0044				
W590	GL-2203				
W591	GL-2204				
W616	GL-1005				
W617	GL-1006				
W618	GL-2303				
W620	GL-1003				
W621	GL-1004				

Leland	Great Lakes Parts	Leland	Great Lakes Parts	Midland	Great Lakes Parts
W660	GL-3960	W660	GL-3960	67211	GL-2001
W694	GL-1001	W694	GL-1001	67212	GL-2002
W695	GL-1002	W695	GL-1002	67213	GL-2101
W709	GL-0052	W709	GL-0052	67214	GL-2102
W720	GL-1009	W720	GL-1009	67266	GL-1007
W721	GL-1010	W721	GL-1010	67266	GL-1011
W722	GL-2009	W722	GL-2009	67267	GL-1012
W723	GL-2010	W723	GL-2010	67267	GL-1008
W746	GL-2003	W746	GL-2003	67268	GL-2013
W747	GL-2004	W747	GL-2004	67269	GL-2014
W748	GL-3006	W748	GL-3006	67272	GL-3098
WT3	GL-5980	WT3	GL-5980	67279	GL-3257
WT4	GL-5985	WT4	GL-5985	67287	GL-1003
WT5	GL-5990	WT5	GL-5990	67288	GL-1004
WT6	GL-5993	WT6	GL-5993	67293	GL-3114
WT7	GL-5992	WT7	GL-5992	67391	GL-1011
WT8	GL-5991	WT8	GL-5991	67392	GL-1012

Mack	Great Lakes Parts	Midland	Great Lakes Parts
15QJ-16	GL-3112	67202	GL-3096
15QJ-17-P1	GL-3113	67203	GL-3097
15QJ-154A	GL-3096	67204	GL-3001
15QJ-210	GL-3087	67205	GL-3002
15QJ-223-BP3	GL-3279	67205	GL-3003
15QJ-223-BP6	GL-3270	67206	GL-3004
15QJ-223-BP8	GL-3271	67206	GL-3004
15QJ-231	GL-3103	67207	GL-3005
15QJ-248	GL-3243	67207	GL-3005
15QJ-249	GL-3244	67209	GL-1001
15QJ-251	GL-3263	67210	GL-1002
18AX-1098	GL-3003		
20AX-8	GL-2408		
21AX-689	GL-2408		
36SZ-102	GL-3001		
69RU-150	GL-4021		
261SZ-188	GL-3004		
264SZ-16	GL-3005		

Motormite	Great Lakes Parts
8900	GL-0014
8904	GL-0086
8906	GL-0027
8907	GL-0026
8908	GL-0016
8909	GL-0031
8915	GL-0073
8918	GL-0047
8920	GL-0052
8925	GL-0059
8926	GL-0058
8928	GL-0092
8930	GL-3004
8933	GL-0055
8934	GL-0056
8935	GL-0044
8937	GL-0051
8938	GL-0057
8939	GL-0338
8940	GL-3005
8943	GL-2101
8944	GL-2102
8949	GL-O110
8950	GL-2001
8951	GL-2002
8954	GL-1001
8955	GL-1002
8958	GL-1011



# Part Number Interchange

Motormite	Great Lakes Parts
8959	GL-1012
8960	GL-0065
8970	GL-0062
8974	GL-0063
8982	GL-0084
8985	GL-0066
9910	GL-0054
9913	GL-0075
9925	GL-0309
9932	GL-0060

Motor Wheel	Great Lakes Parts
M82700	GL-2408
M84523	GL-2101
M84524	GL-2102
M84525	GL-1001
M84526	GL-1002
M84527	GL-2001
M84528	GL-2002
M88881	GL-2302

NAPA	Great Lakes Parts
641-1281	GL-3001
641-2000	GL-1001
641-2001	GL-1002
641-2006	GL-2101
641-2007	GL-2102
641-2010	GL-2001
641-2011	GL-2002
641-2014	GL-2013
641-2015	GL-2014
641-2018	GL-3004
641-2019	GL-3005
641-2263	GL-3096
641-2268	GL-3257
641-2269	GL-3098

National Seal	Great Lakes Parts
357	GL-4974
H075	GL-4913
HU009A	GL-4009
HU014A	GL-4010
733067	GL-4012

NWRA	Great Lakes Parts
B601	GL-3001
B602	GL-3002
N26	GL-3004
N40	GL-3005
W68	GL-3298
W83	GL-3083
W85	GL-3085
W87	GL-3087
W96	GL-3096
W97	GL-3097
W98	GL-3098
W99	GL-3099
W101	GL-3101
W103	GL-3103
W104	GL-3104
W105	GL-3105
W112	GL-3112
W113	GL-3113
W114	GL-3114
W120	GL-3270
W121	GL-3271
W227	GL-3257
W243	GL-3243
W244	GL-3244
W246	GL-3246
W249	GL-3279
W255	GL-3255
W256	GL-3256
W494	GL-3294
X1068	GL-2408
X1110	GL-2202
X1342	GL-2205
X1362	GL-2005
X1363	GL-2006
X1407	GL-1005
X1408	GL-1006
X1416	GL-2007
X1417	GL-2008
X1418	GL-2105
X1419	GL-2106
X1420	GL-2013
X1421	GL-2014
X1470	GL-2201
X1803	GL-2101
X1804	GL-2102
X1807	GL-2103
X1808	GL-2104
X1828	GL-1001
X1829	GL-1002
X1831	GL-2001

NWRA	Great Lakes Parts
X1832	GL-2002
X1835	GL-1003
X1836	GL-1004
X1837	GL-2203
X1838	GL-2204
X2138	GL-1011
X2139	GL-1012
X2143	GL-2302
X2156	GL-2301

Pik-A-Nut	Great Lakes Parts
6141100	GL-2202
6141110	GL-0044
6141200	GL-2408
6141210	GL-3005
6141220	GL-1001
6141221	GL-1002
6141222	GL-1011
6141223	GL-1012
6141250	GL-2205
6141230	GL-2101
6141231	GL-2102
6141700	GL-2001
6141701	GL-2002
6141800	GL-0051
6141810	GL-0055
6141820	GL-0057
6143125	GL-0065
6144125	GL-0065
6144150	GL-0066
6145150	GL-0062
6146125	GL-0072
6146150	GL-0063
6146151	GL-0075
6146169	GL-0110
6146170	GL-0084
6147301	GL-0086
6148000	GL-0046
6148201	GL-0027
6148202	GL-0026
6148203	GL-0016
6148204	GL-0031
6148205	GL-0073
6149010	GL-0058
6149011	GL-0059
6149012	GL-0092
6149013	GL-0054
6149201	GL-0052
6149203	GL-0061



# Part Number Interchange

Rockwell	Great Lakes Parts	Rockwell	Great Lakes Parts	Spicer	Great Lakes Parts
119N118	GL-2001	R854017	GL-2002	08-295	GL-4913
1199B1432	GL-2005	R854019	GL-2001	48-2201	GL-5000
1199C1433	GL-2006	R854025	GL-1006	50-1019L	GL-2106
1199F968	GL-1005	R854026	GL-1005	50-1019R	GL-2105
1199G111	GL-2102	R854027	GL-1008	51-1005L	GL-1002
1199G969	GL-1006	R854028	GL-1007	51-1005R	GL-1001
1199H112	GL-2101	R854029	GL-2008	51-1006L	GL-1004
1199J114	GL-1001	R854032	GL-2007	51-1006R	GL-1003
1199K115	GL-1002	R854034	GL-2105	51-1007L	GL-1006
1199M117	GL-2002	R854035	GL-2014	51-1007R	GL-1005
1199Q1811	GL-2004	R854036	GL 2013	51-1008L	GL-1008
1199Q1863	GL-2106	R854045	GL-2205	51-1008R	GL-1007
1199R1812	GL-2003	R854049	GL-2202	51-1009R	GL-1011
1199R1864	GL-2105	R854050	GL-1004	51-1010L	GL-1012
1199V1348	GL-1007	R854051	GL-1003	51-1012L	GL-2002
1199W1349	GL-1008	R854060	GL-1012	51-1012R	GL-2001
1199XI350	GL-2007	R854067	GL-1011	51-1013L	GL-2102
1199Y1351	GL-2008	R854068	GL-2302	51-1013R	GL-2101
3262S45	GL-4205	R854071	GL-2301	51-1014L	GL-2006
3280S7871	GL-1012	R854082	GL-2204	51-1014R	GL-2005
3280T7872	GL-1011	R854083	GL-2203	51-1015L	GL-2008
R850111	GL-6014	R854094	GL-6023	51-1015R	GL-2007
R851015	GL-6020	R854096	GL-6024	51-1018R	GL-2013
R851016	GL-6021	R856028	GL-3003	51-1018L	GL-2014
R852010	GL-3098	R858006	GL-6025	51-1020	GL-2408
R852022	GL-3096	R858007	GL-6026	51-1029	GL-2201
R852023	GL-3097			51-1029	GL-2202
R852037	GL-3271			51-1030	GL-2202
R852039	GL-3270			51-1031	GL-2205
R852040	GL-3103			51-1045L	GL-1002
R852041	GL-3104			51-1045R	GL-1001
R852042	GL-3099			51-1310	GL-3104
R852044	GL-3279			52-1301	GL-3096
R852050	GL-3112			52-1304	GL-3098
R852051	GL-3113			52-1306	GL-3097
R852052	GL-3114			52-1309	GL-3103
R852054	GL-3087			52-1309	GL-3101
R852063	GL-3108			52-1311	GL-3099
R852066	GL-3105			52-1336	GL-3256
R852067	GL-3243			52-1337	GL-3255
R852068	GL-3255			52-1368	GL-3294
R852070	GL-3256			52-1370	GL-3257
R852073	GL-3083			52-1380	GL-3271
R852075	GL-3298			52-1381	GL-3270
R852081	GL-3263			52-1382	GL-3279
R852082	GL-3294			52-1385	GL-3108
R852083	GL-3101			52-1392	GL-3112
R852092	GL-3244			52-1395	GL-3114
R854015	GL-1002			52-1410	GL-3298
R854016	GL-1001			52-1430	GL-3243
				52-1431	GL-3244

Shrader	Great Lakes Parts
440V	GL-7012
660V	GL-7008
1126-250	GL-7021
1250A	GL-7135
2316C	GL-7002
3522	GL-7061
5265	GL-7001
5499	GL-7305
6529	GL-7318
6739	GL-7315
7188L	GL-7155
7572V	GL-7003
7760A	GL-7105
8101A	GL-7115
8102A	GL-7130
8159B	GL-7335
9994L	GL-7330

Spicer	Great Lakes Parts
08-293	GL-4205





# Part Number Interchange

Spicer	Great Lakes Parts
52-1436	GL-3087
52-1440	GL-3083
52-1441	GL-3085
53-1500	GL-3001
53-1501	GL-3002
53-1501	GL-3003
53-1560	GL-3004
53-1561	GL-3005
54-1644	GL-6020
54-1651	GL-6021
54-1660	GL-6023
54-1661	GL-6024

Stemco	Great Lakes Parts
330-3009	GL-4012
330-3067	GL-4013
330-3077	GL-4974
340-4009	GL-4009
340-4010	GL-4010
340-4075	GL-4075
340-5097	GL-4205
359-5990	GL-4021
359-5995	GL-4020
640-0001	GL-4069
640-0003	GL-4964

Trail-Mobile	Great Lakes Parts
3-23-7	GL-6023
8-1-63	GL-3004
8-8-6	GL-3096
8-8-17	GL-3097
8-8-20	GL-3098
8-9-7	GL-3001
8-9-8	GL-3002
8-15-4	GL-3005
21-W158	GL-1003
21-w159	GL-1004
21-W182	GL-2202
30-93900025	GL-6025
50-34a1	GL-2101
50-34a2	GL-2102
50-34b1	GL-1001
50-34B2	GL-1002
50-34B5	GL-1011
50-34B6	GL-1012
50-34B11	GL-1007
50-34B12	GL-1008
50-34C1	GL-2001

Trail-Mobile	Great Lakes Parts
50-34C2	GL-2002
50-34C5	GL-2013
50-34C6	GL-2014
50-34C9	GL-2105
50-34C10	GL-2106
50-34C13	GL-2007
50-34C14	GL-2008
50-34C19	GL-2302
700-7-78	GL-1005
700-7-80	GL-1006
700-7-81	GL-2003
700-7-82	GL-2004
700-7-226	GL-2301
15296	GL-4020
16036	GL-4021
19143	GL-4205
32000	GL-4974

Tri-Seal	Great Lakes Parts
61067G	GL-4012
61077G	GL-4974
64010	GL-4010
64046	GL-4009

Wagner	Great Lakes Parts
916000	GL-3004
916001	GL-3005
916010	GL-3001
916040	GL-3096
916042	GL-3097
916045	GL-3098
916100	GL-1001
916101	GL-1002
916102	GL-1003
916103	GL-1004
916104	GL-1005
916106	GL-1006
916112	GL-1011
916113	GL-1012
916116	GL-2001
916117	GL-2002

Webb	Great Lakes Parts
3314	GL-3298
10708	GL-1001
10709-1	GL-1002
16123	GL-3096

Webb	Great Lakes Parts
16124	GL-3101
16129	GL-3098
74611	GL-3004
74710	GL-3005
86222	GL-6020
105988	GL-1011
105989	GL-1012
161127	GL-3001
171027	GL-3003
178736	GL-2101
178737	GL-2102
178910	GL-2001
178921	GL-2002
179933	GL-2301
179955	GL-2302

White Motor	Great Lakes Parts
300190	GL-2102
300191	GL-2101
300248	GL-2002
300249	GL-2001
361045	GL-2408
426956	GL-3002
426957	GL-3096
443386PS	GL-4021
448888A	GL-3097
451061A	GL-3098
477091	GL-1011
477092	GL-1012
499716	GL-3083
684628	GL-3103
689783	GL-3003
828437	GL-2007
858364	GL-4020
861634	GL-3001
872325	GL-1008
872331	GL-1007
874603	GL-2006
874608	GL-2005
90301001	GL-3244
27022252	GL-3243
A13817X	GL-3005
A300248X	GL-2002
A200249X	GL-2001
B4919X	GL-1001
B4920X	GL-1002
Y481084	GL-1006
Y481085	GL-1005
Y484442	GL-1004
Y484443	GL-1003

# Conversion Chart

Inch Fractions and Decimals to Metric Equivalents

INCHES		MM	INCHES		MM	INCHES		MM	INCHES		MM
Fractions	Decimals		Fractions	Decimals		Fractions	Decimals		Fractions	Decimals	
—	.0004	.01	—	.4331	11	31/32	.96875	24.606	1-7/8	1.875	47.625
—	.004	.10	7/16	.4375	11.113	—	.9843	25	—	1.8898	48
—	.01	.25	29/64	.4531	11.509	1	1.000	25.4	1-29/32	1.9062	48.419
1/64	.0156	.397	15/32	.46875	11.906	—	1.0236	26	—	1.9291	49
—	.0197	.50	—	.4724	12	1-1/32	1.0312	26.194	1-15/16	1.9375	49.213
—	.0295	.75	31/64	.48437	12.303	1-1/16	1.062	26.988	—	1.9685	50
1/32	.03125	.794	—	.492	12.5	—	1.063	27	1-31/32	1.969	50.006
—	.0394	1	1/2	.500	12.700	1-3/32	1.094	27.781	2	2.000	50.800
3/64	.0469	1.191	—	.5118	13	—	1.1024	28	—	2.0079	51
—	.059	1.5	33/64	.5156	13.097	1-1/8	1.125	28.575	—	2.0472	52
1/16	.0625	1.588	17/32	.53125	13.494	—	1.1417	29	2-1/16	2.062	52.388
5/64	.0781	1.984	35/64	.54687	13.891	1-5/32	1.156	29.369	—	2.0866	53
—	.0787	2	—	.5512	14	—	1.1811	30	2-1/8	2.125	53.975
3/32	.094	2.381	9/16	.5625	14.288	1-3/16	1.1875	30.163	—	2.126	54
—	.0984	2.5	—	.571	14.5	1-7/32	1.219	30.956	—	2.165	55
7/64	.1093	2.776	37/64	.57812	14.684	—	1.2205	31	2-3/16	2.1875	55.563
—	.1181	3	—	.5906	15	1-1/4	1.250	31.750	—	2.2047	56
1/8	.1250	3.175	19/32	.59375	15.081	—	1.2598	32	—	2.244	57
—	.1378	3.5	39/64	.60937	15.478	1-9/32	1.281	32.544	2-1/4	2.250	57.150
9/64	.1406	3.572	5/8	.6250	15.875	—	1.2992	33	—	2.2835	58
5/32	.15625	3.969	—	.6299	16	1-5/16	1.312	33.338	2-5/16	2.312	58.738
—	.1575	4	41/64	.6406	16.272	—	1.3386	34	—	2.3228	59
11/64	.17187	4.366	—	.6496	16.5	1-11/32	1.344	34.131	—	2.3622	60
—	.177	4.5	21/32	.65625	16.669	1-3/8	1.375	34.925	2-3/8	2.375	60.325
3/16	.1875	4.763	—	.6693	17	—	1.3779	35	—	2.4016	61
—	.1969	5	43/64	.67187	17.066	1-13/32	1.406	35.719	2-7/16	2.438	61.913
13/64	.2031	5.159	11/16	.6875	17.463	—	1.4173	36	—	2.4409	62
—	.2165	5.5	45/64	.7031	17.859	1-7/16	1.438	36.513	—	2.4803	63
7/32	.21875	5.556	—	.7087	18	—	1.4567	37	2-1/2	2.500	63.500
15/64	.23437	5.953	23/32	.71875	18.256	1-15/32	1.469	37.306	—	2.5197	64
—	.2362	6	—	.7283	18.5	—	1.4961	38	—	2.559	65
1/4	.2500	6.350	47/64	.73437	18.653	1-1/2	1.500	38.100	2-9/16	2.562	65.088
—	.2559	6.5	—	.7480	19	1-17/32	1.531	38.894	—	2.5984	66
17/64	.2656	6.747	3/4	.7500	19.050	—	1.5354	39	2-5/8	2.625	66.675
—	.2756	7	49/64	.7656	19.447	1-9/16	1.562	39.688	—	2.638	67
9/32	.28125	7.144	25/32	.78125	19.844	—	1.5748	40	—	2.6772	68
—	.2953	7.5	—	.7874	20	1-19/32	1.594	40.481	2-11/16	2.6875	68.263
19/64	.29687	7.541	51/64	.79687	20.241	—	1.6142	41	—	2.7165	69
5/16	.3125	7.938	13/16	.8125	20.638	1-5/8	1.625	41.275	2-3/4	2.750	69.850
—	.3150	8	—	.8268	21	—	1.6535	42	—	2.7559	70
21/64	.3281	8.334	53/64	.8281	21.034	1-21/32	1.6562	42.069	—	2.7953	71
—	.335	8.5	27/32	.84375	21.431	1-11/16	1.6875	42.863	2-13/16	2.8125	71.438
11/32	.34375	8.731	55/64	.85937	21.828	—	1.6929	43	—	2.8346	72
—	.3543	9	—	.8662	22	1-23/32	1.719	43.656	—	2.8740	73
23/64	.35937	9.128	7/8	.8750	22.225	—	1.7323	44	2-7/8	2.875	73.025
—	.374	9.5	57/64	.8906	22.622	1-3/4	1.750	44.450	—	2.9134	74
3/8	.3750	9.525	—	.9055	23	—	1.7717	45	2-15/16	2.9375	74.613
25/64	.3906	9.922	29/32	.90625	23.019	1-25/32	1.781	45.244	—	2.9527	75
—	.3937	10	59/64	.92187	23.416	—	1.8110	46	—	2.9921	76
13/32	.4062	10.319	15/16	.9375	23.813	1-13/16	1.8125	46.038	3	3.000	76.200
—	.413	10.5	—	.9449	24	1-27/32	1.844	46.831	—	—	—
27/64	.42187	10.716	61/64	.9531	24.209	—	1.8504	47	—	—	—

**GLP**



**Great Lakes Parts, Inc.**

130 Ken Mar Drive, Cleveland, OH 44147

(440) 546-0304

Fax (440) 546-0306

[info@glparts.com](mailto:info@glparts.com)

[www.glparts.com](http://www.glparts.com)